

# LM3620

## Lithium-Ion Battery Charger Controller

### General Description

The LM3620 series of controllers are monolithic integrated circuits designed to control the charging and end-of-charge control for lithium-ion rechargeable batteries. The LM3620 is available in two versions for one or two cell charger applications. Each version provides the option of selecting the appropriate termination voltage for either coke or graphite anode lithium cells.

The LM3620 can operate from a wide range of DC input sources (4V to 30V). With no charger supply connected, the controller draws a quiescent current of only 10nA to minimize discharging of a connected battery pack.

The LM3620 consists of an operational transconductance amplifier, a bandgap voltage reference, a NPN driver transistor and precision voltage setting resistors. The output of the amplifier is made available to drive an external power transistor if higher drive currents are required.

With a trimmed output voltage regulation of  $\pm 1.2\%$  initial accuracy, the LM3620 provides a simple, precise solution for end-of-charge control of lithium-ion rechargeable cells.

The LM3620 is packaged in a miniature 5-lead SOT-23 surface mount package for very compact designs.

### Features

- Voltage options for charging 1 or 2 cell stacks
- Adjustable output voltage for coke or graphite anodes
- Precision end-of-charge voltage control
- Wide input voltage range (4V to 30V)
- Low off state current (<10nA)
- Drive provided for external power stage
- Tiny SOT-23 package

### Typical Application

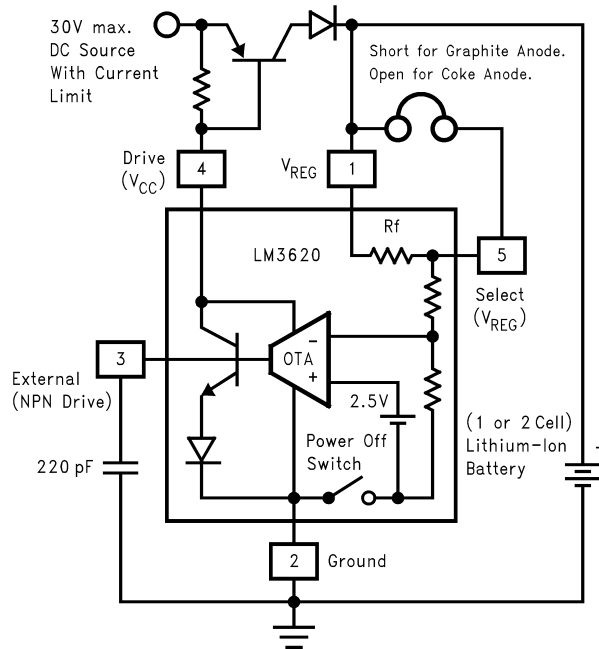

10084110

## Connection Diagram

### 5-Lead SOT23-5 Surface Mount Package

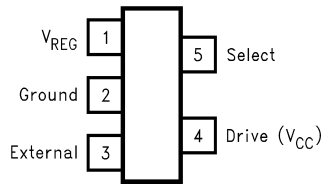

10084101

Refer to the Ordering Information Table in this Data Sheet for Specific Part Number

See NS Package MF05A

## Ordering Information

Device Order Number	Package Marking	Output Voltage	Initial Accuracy (25°C)	Over Temperature Accuracy (0 to 70°C)	Number of Cells	Supplied as
LM3620M5-4	D10B	4.1V/4.2V	1.2%	2%	1	1000 Unit increments on Tape and Reel
LM3620M5X-4	D10B	4.1V/4.2V	1.2%	2%	1	3000 Unit increments on Tape and Reel
LM3620M5-8	D11B	8.2V/8.4V	1.2%	2%	2	1000 Unit increments on Tape and Reel
LM3620M5X-8	D11B	8.2V/8.4V	1.2%	2%	2	3000 Unit increments on Tape and Reel

The small physical size of the SOT23-5 Package does not allow for the full part number marking. Devices will be marked with the designation shown in the column Package Marking.

The devices are shipped in tape-and-reel format. The standard quantity is 250 units on a reel (indicated by the letters "M5" in the part number), or 3000 units on a reel (indicated by the letters "M5X" in the part number).

**Absolute Maximum Ratings** (Note 1)

If Military/Aerospace specified devices are required, please contact the National Semiconductor Sales Office/Distributors for availability and specifications.

Input Voltage ( $V_{DRIVE}$ )	35V
$V_{EXT}$	1.5V
Junction Temperature	150°C
Storage Temperature	-65 to +150°C
Lead Temp. Soldering	
Vapor Phase (60 sec.)	215°C
Infrared (15 sec.)	220°C

Power Dissipation ( $T_A = 25^\circ\text{C}$ )	300mW
(Note 2)	
ESD Susceptibility (Note 3)	2000V

**Operating Ratings** (Note 1)

Ambient Temp. Range	0°C to 70°C
Junction Temp. Range	0°C to 125°C
Thermal Resistance (Junction to Ambient, $\theta_{J-A}$ )	280°C/W
Input Voltage ( $V_{DRIVE}$ )	4V to 30V

**Electrical Characteristics****LM3620-4**

$V_{DRIVE} = 5V$ ,  $I_{DRIVE} = 2mA$ . Limits with **boldface type** apply over the full operating ambient temperature range, 0°C to +70°C, limits with standard typeface apply for  $T_A = 25^\circ\text{C}$ .

Symbol	Parameter	Conditions	Typical	Limit	Units
$V_{REG}$	Regulated Output Voltage (pin 1 to ground)	Pin 5 shorted to pin 1 (graphite anode)	4.1	4.051/ <b>4.018</b>	V(min)
		Pin 5 open (coke anode)	4.2	4.149/ <b>4.182</b>	V(max)
	Regulated Output Voltage Tolerance	Either Pin 5 setting		4.150/ <b>4.116</b>	V(min)
				4.250/ <b>4.284</b>	V(max)
				$\pm 1.2/\pm 2.0$	%
$V_{REG}/V_{DRIVE}$	Supply Sensitivity	$V_{REG}$ for $5V \leq V_{DRIVE} \leq 30V$	100		$\mu\text{V}/\text{V}(\text{max})$
$I_Q$	Quiescent Current	$V_{REG} = 4.5V$ , $V_{EXT} = 1.0V$ (Note 4)	400	<b>750</b>	$\mu\text{A}(\text{max})$
$I_{OFF}$	Off State Current	$V_{DRIVE}$ open circuited (Note 5)	10	<b>200</b>	nA(max)
$I_{DRIVE}$	Drive Pin Sink Current	$V_{DRIVE} = 5.0V$	20	<b>15</b>	mA(min)
$G_{m(DRIVE)}$	Drive Pin Transconductance	$\Delta I_{DRIVE}/\Delta V_{REG}$ $2mA \leq I_{DRIVE} \leq 15mA$	3		A/V
$I_{EXT}$	External Pin Source Current	$V_{EXT} = 1V$ (Note 6)	3	<b>2.5</b>	mA(min)
$G_{m(EXT)}$	External Pin Transconductance	$\Delta I_{EXT}/\Delta V_{REG}$ , $V_{EXT} = 1V$ $0mA \leq I_{EXT} \leq 2.5mA$	0.8		A/V
$R_{IN}$	$V_{REG}$ Input Resistance	Pin 1 to Ground.			
		Circuit biased with $V_{DRIVE}$ applied $V_{DRIVE}$ open circuited	46		k $\Omega$
			42		M $\Omega$
$R_F$	Feedback Resistance	Pin 1 to Pin 5	1500		$\Omega$

## Electrical Characteristics (Continued)

### LM3620-8

$V_{DRIVE} = 5V$ ,  $I_{DRIVE} = 2mA$ . Limits with **boldface type** apply over the full operating ambient temperature range,  $0^{\circ}C$  to  $+70^{\circ}C$ , limits with standard typeface apply for  $T_A = 25^{\circ}C$ .

Symbol	Parameter	Conditions	Typical	Limit	Units	
$V_{REG}$	Regulated Output Voltage (pin 1 to ground)	Pin 5 shorted to pin 1 (graphite anode)	8.2	8.102/ <b>8.036</b>	V(min)	
		Pin 5 open (coke anode)	8.4	8.299/ <b>8.232</b>	V(max)	
	Regulated Output Voltage Tolerance	Either Pin 5 setting			8.501/ <b>8.568</b>	V(max)
					$\pm 1.2/\pm 2.0$	%
$V_{REG}/V_{DRIVE}$	Supply Sensitivity	$V_{REG}$ for $5V \leq V_{DRIVE} \leq 30V$	200		$\mu V/V(\max)$	
$I_Q$	Quiescent Current	$V_{REG} = 8.7V$ , $V_{EXT} = 1.0V$ (Note 4)	400	<b>750</b>	$\mu A(\max)$	
$I_{OFF}$	Off State Current	$V_{DRIVE}$ open circuited (Note 5)	10	<b>200</b>	nA(max)	
$I_{DRIVE}$	Drive Pin Sink Current	$V_{DRIVE} = 5.0V$	20	<b>15</b>	mA(min)	
$G_{m(DRIVE)}$	Drive Pin Transconductance	$\Delta I_{DRIVE}/\Delta V_{REG}$ $2mA \leq I_{DRIVE} \leq 15mA$	1.5		A/V	
$I_{EXT}$	External Pin Source Current	$V_{EXT} = 1V$ (Note 6)	3	<b>2.5</b>	mA(min)	
$G_{m(EXT)}$	External Pin Transconductance	$\Delta I_{EXT}/\Delta V_{REG}$ , $V_{EXT} = 1V$ $0mA \leq I_{EXT} \leq 2.5mA$	0.4		A/V	
$R_{IN}$	$V_{REG}$ Input Resistance	Pin 1 to Ground.				
		Circuit biased with $V_{DRIVE}$ applied $V_{DRIVE}$ open circuited	110 42		k $\Omega$ M $\Omega$	
$R_F$	Feedback Resistance	Pin 1 to Pin 5	2900		$\Omega$	

**Note 1:** Absolute Maximum Ratings indicate limits beyond which damage to the device may occur. Operating Ratings indicate conditions for which the device is intended to be functional, but do not guarantee specific performance limits. For guaranteed specifications and test conditions, see the Electrical Characteristics.

**Note 2:** The maximum power dissipation must be derated at elevated temperatures and is limited by  $T_{JMAX}$  (maximum junction temperature),  $\theta_{JA}$  (junction-to-ambient thermal resistance) and  $T_A$  (ambient temperature). The maximum power dissipation at any temperature is:  $P_{DISSMAX} = (T_{JMAX} - T_A)/\theta_{JA}$  up to the value listed in the Absolute Maximum Ratings.

**Note 3:** Rating is for the human body model, a 100 pF capacitor discharged through a 1.5k $\Omega$  resistor into each pin.

**Note 4:** Quiescent current is all current flowing to ground when the voltage at the  $V_{REG}$  pin is forced to be above the nominal regulating voltage ( $V_{REG}$ ).

**Note 5:** Off current is all of the current flowing to ground including all leakage current that would be drawn from the battery connected to the  $V_{REG}$  terminal.

**Note 6:** When the External pin is being used as the driving source, it is recommended to keep the operating point of  $V_{EXT} \leq 1V$ . If greater than 1V, the internal circuitry would bias  $I_{DRIVE}$  to conduct up to the current limit level continuously causing unnecessary power dissipation in the device.

# Typical Performance Characteristics

Unless otherwise specified,  $T_A = 25^\circ\text{C}$ .

**LM3620M5-4**  
**Normalized Regulation Voltage Change vs  $I_{\text{DRIVE}}$**

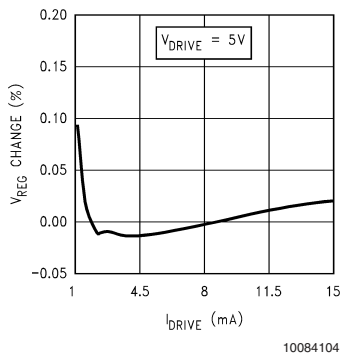

**LM3620M5-4**  
**Normalized Regulation Voltage Change vs  $V_{\text{DRIVE}}$**

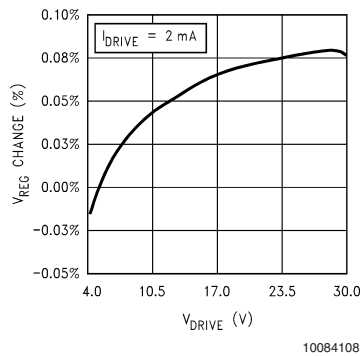

**LM3620M5-4**  
**Normalized Regulation Voltage Change vs  $I_{\text{EXT}}$**

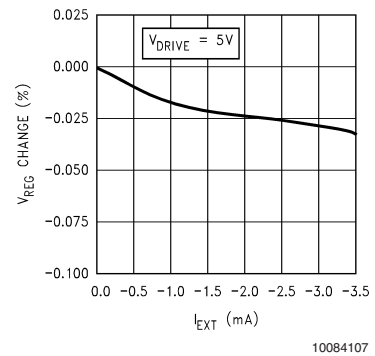

**LM3620M5-4**  
**Quiescent Current vs  $V_{\text{DRIVE}}$**

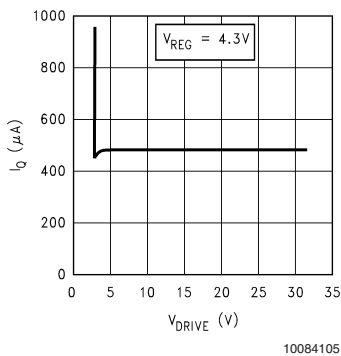

**LM3620M5-4**  
**Off State Current vs  $V_{\text{DRIVE}}$**

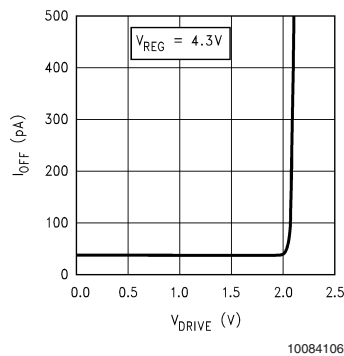

**LM3620M5-4**  
**Off State Current vs Temperature**

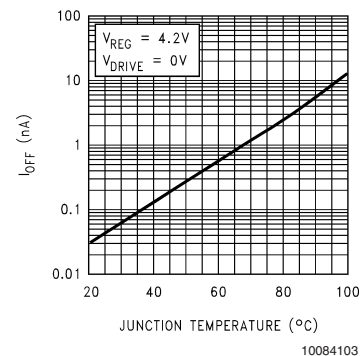

**LM3620M5-4**  
**Bode Plot ( $\Delta V_{\text{DRIVE}}/\Delta V_{\text{REG}}$ )**

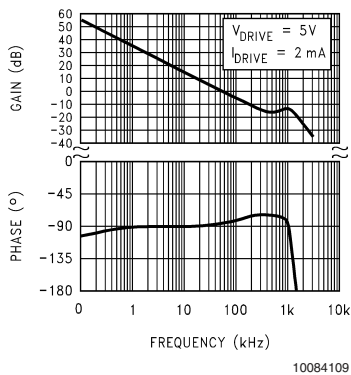

**Physical Dimensions** inches (millimeters) unless otherwise noted

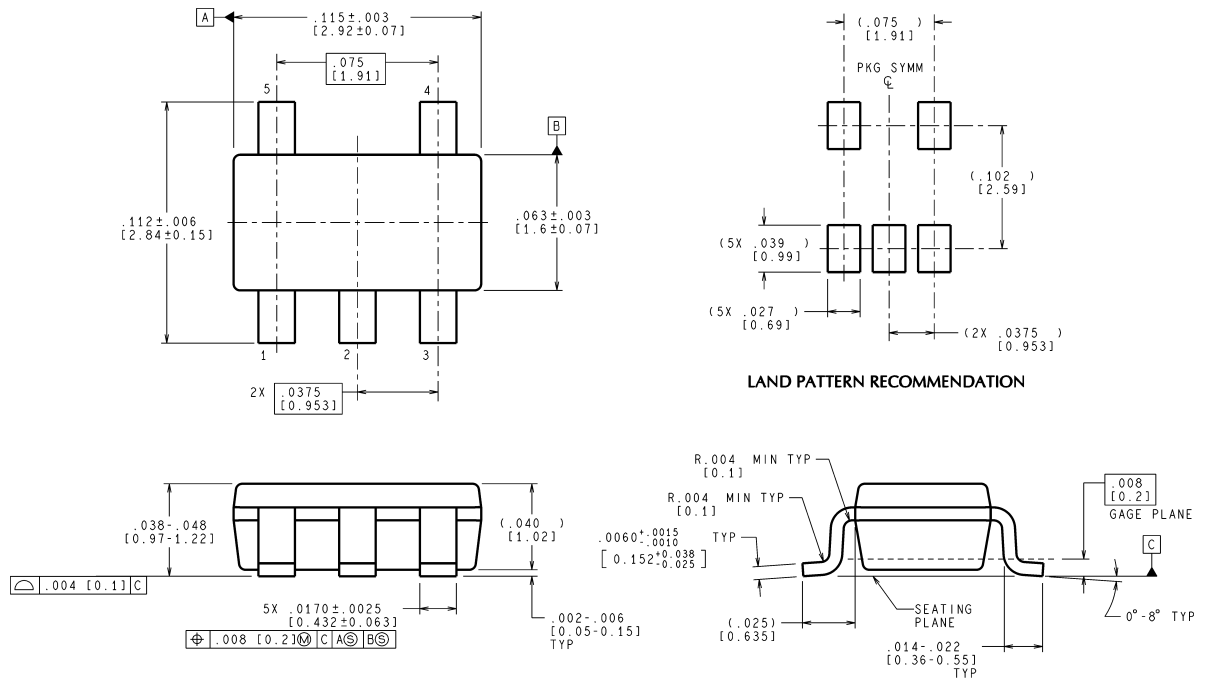

CONTROLLING DIMENSION IS INCH  
VALUES IN [ ] ARE MILLIMETERS

MF05A (Rev B)

**SOT23-5 Package**  
**5-Lead Small-Outline Package (M5)**  
For Ordering, Refer to Ordering Information Table  
NS Package Number MF05A

National does not assume any responsibility for use of any circuitry described, no circuit patent licenses are implied and National reserves the right at any time without notice to change said circuitry and specifications.

For the most current product information visit us at [www.national.com](http://www.national.com).

**LIFE SUPPORT POLICY**

NATIONAL'S PRODUCTS ARE NOT AUTHORIZED FOR USE AS CRITICAL COMPONENTS IN LIFE SUPPORT DEVICES OR SYSTEMS WITHOUT THE EXPRESS WRITTEN APPROVAL OF THE PRESIDENT AND GENERAL COUNSEL OF NATIONAL SEMICONDUCTOR CORPORATION. As used herein:

1. Life support devices or systems are devices or systems which, (a) are intended for surgical implant into the body, or (b) support or sustain life, and whose failure to perform when properly used in accordance with instructions for use provided in the labeling, can be reasonably expected to result in a significant injury to the user.
2. A critical component is any component of a life support device or system whose failure to perform can be reasonably expected to cause the failure of the life support device or system, or to affect its safety or effectiveness.

**BANNED SUBSTANCE COMPLIANCE**

National Semiconductor certifies that the products and packing materials meet the provisions of the Customer Products Stewardship Specification (CSP-9-111C2) and the Banned Substances and Materials of Interest Specification (CSP-9-111S2) and contain no "Banned Substances" as defined in CSP-9-111S2.

 **National Semiconductor**  
Americas Customer  
Support Center  
Email: [new.feedback@nsc.com](mailto:new.feedback@nsc.com)  
Tel: 1-800-272-9959

**National Semiconductor**  
Europe Customer Support Center  
Fax: +49 (0) 180-530 85 86  
Email: [europe.support@nsc.com](mailto:europe.support@nsc.com)  
Deutsch Tel: +49 (0) 69 9508 6208  
English Tel: +44 (0) 870 24 0 2171  
Français Tel: +33 (0) 1 41 91 8790

**National Semiconductor**  
Asia Pacific Customer  
Support Center  
Email: [ap.support@nsc.com](mailto:ap.support@nsc.com)

**National Semiconductor**  
Japan Customer Support Center  
Fax: 81-3-5639-7507  
Email: [jpn.feedback@nsc.com](mailto:jpn.feedback@nsc.com)  
Tel: 81-3-5639-7560